

**Barrier Style Terminal Blocks / DT-2**

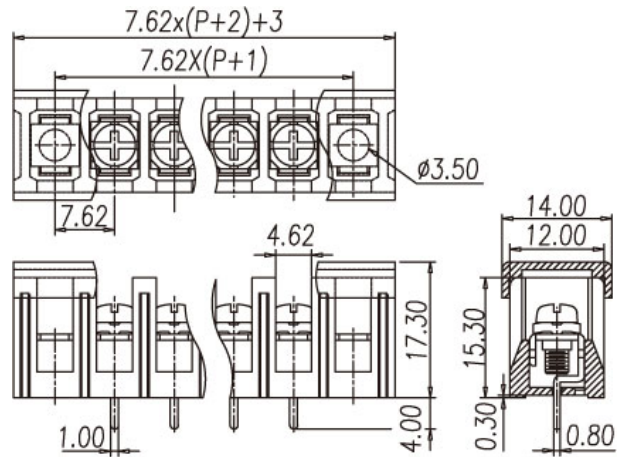

**DT-2X-A01X-XX**



**Pitch:7.62mm**

**ORDER GUIDE**

**DT - 2**  -  **01**  -

- Pole size: 02~34P
- N : Round head screw
- W : Screw with washer
- A : Mount Ends
- B : Barrier Ends
- C : With cover
- N : Without cover

Approval



FW2

**Materials**

Rated voltage	300V
Rated current	15A
Plastic Housing	PBT, UL94V-0, Black
Terminal	Brass, Tin plated
Screw	Steel, M3, Nickel plated



### Specifications

Working Temperature	-40°C ~ +130°C
Insulation withstand Voltage	AC2000V at 1 minute
Insulation Resistance	1000MΩ or more at DC500V
Wire range	22 ~ 14 AWG
Rated Torque Value	8 Kg - cm